

Product Guide

IMAGE-LED Lighting System

BOKY10

CODE : BK-13011

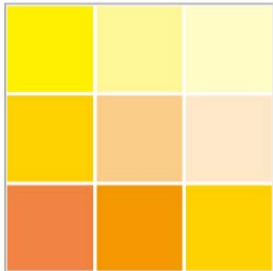

CELL INTERNATIONAL www.zcell.kr

304-1 Ohyang-Ri Silchon-Eup Gwangju-Si Gyeonggi-Do 464-875 Korea, Tel 031-764-8442, Fax 031-764-8443 Email cell@zcell.kr



BOKY10 is composed by square type of pixel to create abstract and soft moving image and bring you in the world of incalculable numbers of fantastic color. (16,700,000 colors)

above all cased in unit 300x300mm with easy block mounting system to construct screen or display upon requested dimension.

is also with easy control system either for operation & maintenance or installation & transportation.

BOKY10 can be applied at exhibition & shopping mall for displays, in discotheque & club or pub as dynamic back screen, stage of theater, broadcasting studios and concert.

further to interactive system it can be applied as a new paradigm by media or digital artists.

1. MODEL

IMAGE-LED FIXTURE

BK-13011 BOKY10

ACCESSORIES

- BK-24027 BOKY10 FIXING KIT
- BK-24011 AC EXTENSION CABLE 60cm
- BK-24014 XLR EXTENSION CABLE 60cm
- BK-24015 XLR EXTENSION CABLE 150cm
- BK-24016 OPTIC CABLE 5m
- BK-24017 OPTIC CABLE 10m
- BK-24018 OPTIC CABLE 20m
- BK-24028 BOKY10 BASE PLATE

CONTROL SYSTEM

- CT-15041 A-SUB CONTROL
- CT-15032 B-PROCESSOR
- CT-15033 B-WORKS
- CT-15034 OPTIC SPLITTER

2. SPECIFICATIONS

- Light and compact basic unit case : size in 301x301mm
- SMPS installed inside to be enable to connect directly to AC 100~240V
- Connection between units by just one line of cable (Daisy Chain)
- No need to feed the addresses of control by automatic system of communication
- High quality of diffuser panel, uniformity of beam light and without loss of brightness
- Creation of artful letters, pictures and moving image through control system

3. TECHNICAL DATA

- PRODUCT CODES : BK-13011
- MATERIAL : Hot stabilized techno-polymer body with opal matt acryl cover
- DIMENSIONS : 301mm x 301mm x 145mm
- WEIGHT : 4.0Kg
- PROTECTION CLASS : IP20, Class I
- OPERATING TEMPERATURE : -20°C~65°C
- POWER SUPPLY : 100~240VAC 50~60Hz
- POWER CONSUMPTION : 35W Max
- LED : RGB 3in1 SMD 81LED
- PIXEL : 100x100mm Square 9pixel
- PIXEL PITCH : 100mm
- VIEW ANGLE : 140°x140°
- CONTROL : IMAGE-LED Protocol



4. DRAWING & MOUNTING DIAGRAM

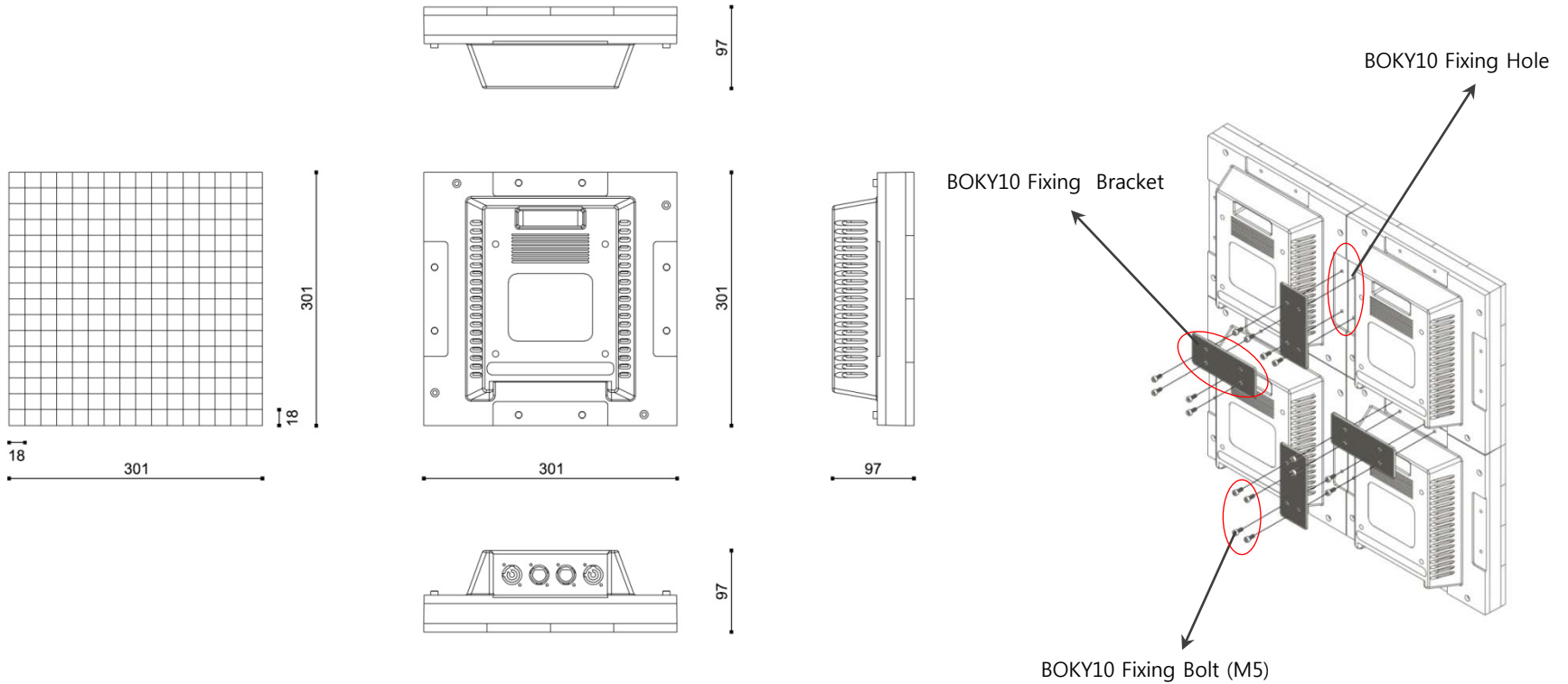

5. WIRING DIAGRAM

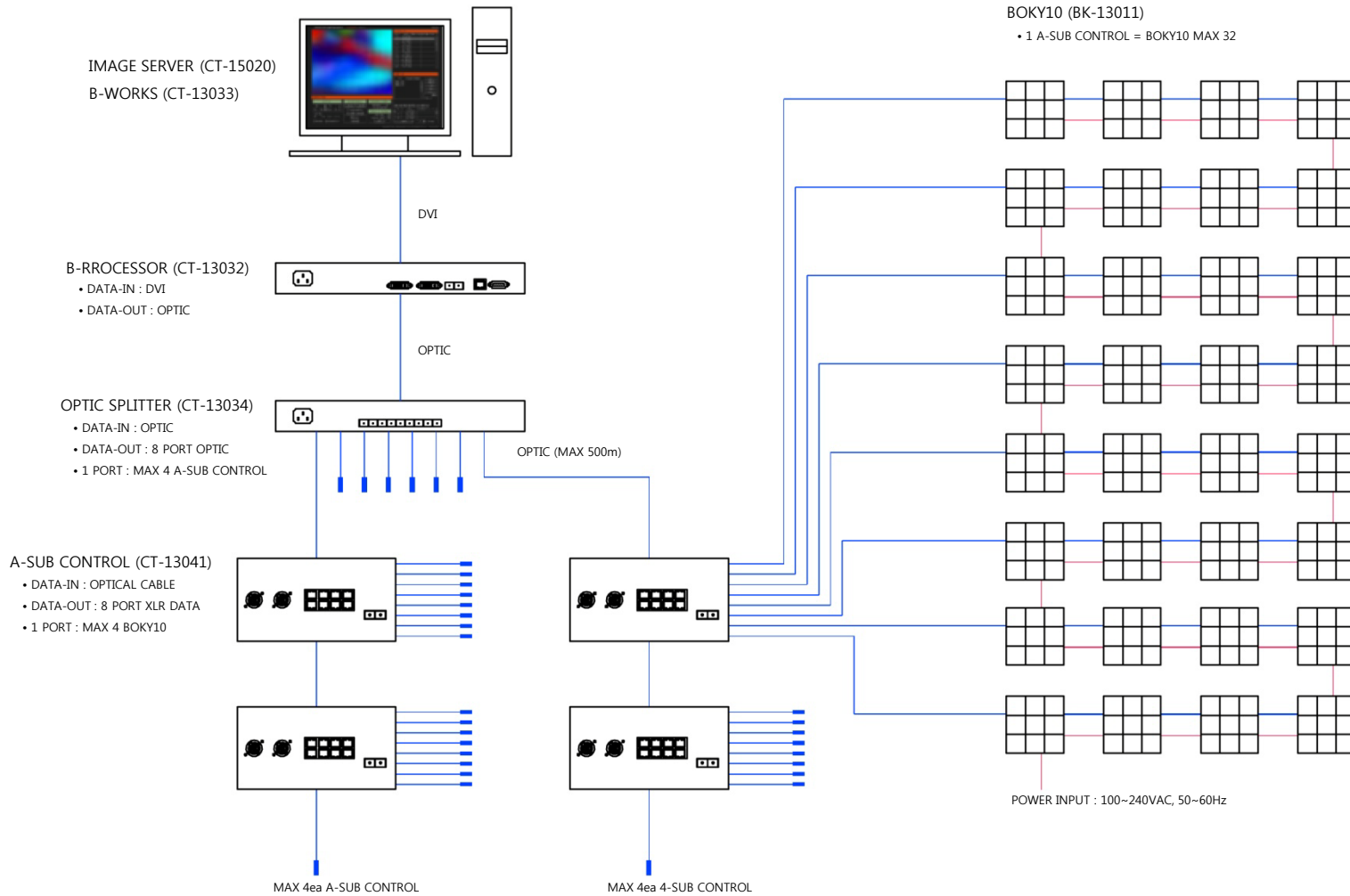

※ EXAMPLE – BOKY10 60set<Width 6, Height 10>

